

# EasyLED Bentley Kitty Hawk Powerbolt

FXKH55Q

SOFTLED • POWERBOLT • AREA LIGHT • FLOOD LIGHT



The FXKH55Q PowerBolt luminaire is available with a wide choice of optical distributions designed to replace HID lighting systems to 1500w MH or HPS. Typical applications include general area, parking, flood, and security lighting for auto dealerships, retail centers, industrial parks, schools and universities, public transit and airports, office buildings and medical facilities. Mounting heights of 20 to 50 feet can be used based on light level and uniformity requirements.

## HOUSING:

Die Cast Aluminum Housing and Front Frame, Integral Heat Sinking and Driver Compartment. Photocell Adaptable. Nickel-Plated Stainless Steel Hardware.

## LISTING & RATINGS:

CSA: Listed for Wet Locations, ANSI/UL 1598, 8750; IP66 Sealed LED Compartment.

## FINISH:

Textured Architectural Bronze Powdercoat Finish Over a Chromate Conversion Coating. Custom Colors Available Upon Request.

## LENS:

Tempered Clear Flat, SoftLED Flat Glass Lens, or Tempered Clear Flat Prismatic Glass Lens.

## MOUNTING OPTIONS:

Mounts with Adjustable Slipfitter. (Factory Installed)

## EASYLED LED:

Aluminum Boards

## DRIVER:

Electronic Driver, 120-277V, 50/60Hz or 347-480V, 50/60Hz; Less Than 20% THD and PF>0.90. Standard Internal Surge Protection 6kV. 0-10V Dimming Standard for a Dimming Range of 100% to 10%; Dimming Source Current is 150 Microamps.

## CONTROLS:

Fixtures Ordered with Factory-Installed Photocell or Motion Sensor Controls are Internally Wired for Switching and/or 1-10V Dimming Within the Housing. Remote Direct Wired Interface of 1-10V Dimming is Not Implied and May Not Be Available, Please Consult Factory. Fixtures are Tested with FX Lighting Controls and May Not Function Properly With Controls Supplied By Others. Fixtures are NOT Designed for Use with Line Voltage Dimmers.

## LIFESPAN:

L70>290,000 Hours

## WARRANTY:

5-Year Warranty for -40°C to +50°C Environment.

See Page 5 for Projected Lumen Maintenance Table.



Shown with Pole Mounted Slipfitter.

Shown with "SF" Slipfitter Mounting Option.



PROJECT INFORMATION:	
Project Name:	Fixture Type:
Complete Catalog #:	Date:
Comments:	

FXLSolutions.com • (800) 533-2789 • info@FXLSolutions.com

# EasyLED Bentley Kitty Hawk Powerbolt

FXKH55Q

SOFTLED • POWERBOLT • AREA LIGHT • FLOOD LIGHT



We have custom and standard manufacturing options. Use this form to build your part number or reach out to our sales team for assistance.

**GET YOUR PRODUCTS FASTER WITH OUR QUICK SHIP PROGRAM**

Multiple USA locations = 98-3-1 Quick Ship Program

98% Fill Rate – 3 Day Lead Time – 1 Piece Minimum Order

## ORDER EXAMPLE

Optics
Driver
Lens
Mounting

FXKH55Q
F
2X256
U
5K
C
Z
SF
SP

Series
Wattage
CCT
Color
Options

## ORDER CONFIGURATION

Series	Optics	Wattage	Driver	CCT	Lens	Color	Mounting	Options
FXKH55Q=Bentley Kitty Hawk PowerBolt Area and Flood Light	A=Type I/NEMA 7H x 5V B=Type II/NEMA 7H x 6V C=Type III/NEMA 7H x 7V D=Type IV/NEMA 6H x 5V F=Type V/NEMA 7H x 7V I=Narrow Beam/NEMA 4H x 4V* *334 & 512w, 5K Models Only. See Page 4 & 6 for Distribution Information.	OPTIMIZED 2X136=272w 2X167=334w OPTIMIZED 2X225=450w 2X256=512w	U=120-277V H=347-480V	3K=3000K* 4K=4000K 5K=5000K *334 & 512w, F & C Optics.	C=Standard Clear Flat Glass Lens S=SoftLED Flat Glass Lens* P=Clear Flat Prismatic* Glass Lens* *Type V Optic Only.	Z=Bronze C=Custom (Consult Factory)	SF=Slipfitter, Included	SF=Single Fuse* DF=Double Fuse* SP=Surge Protection R3=3-Pin Twist Lock Photocell Receptacle R5=5-Pin Twist Lock Photocell Receptacle R7=7-Pin ANSI C136.41-2013 Twist Lock Photocell Receptacle S23=Internal Microwave Sensor with dimming for mounting heights of 35" or less.* S43=Microwave On/Off Motion Sensor for Mounting Heights of 8' to 19'.* *120-277V Model Only
FXKH55Q							SF	

## Mounting Accessories

(Order Separately, Field Installed)

Options	Description
FXPTS1SZ	Single Pole Tenon Spoke Bracket, 2 3/8" Horizontal Mounting Arm, Bronze Powdercoat Finish, Includes Hardware.
FXPTS2180SZ	Twin Pole Tenon Spoke Bracket, 2 3/8" Horizontal 180° Mounting Arms, Bronze Powdercoat Finish, Includes Hardware.

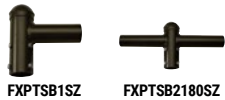

FXPTS1SZ FXPTS2180SZ

## Accessories

(Order Separately, Field Installed)

Options	Description
FXP18131	Twist Lock Non-Shorting (Open) Cap Disconnects Service to Fixture for Temporary or Permanent Disabling (Fixture Always Off). IP65, 480V Maximum.
FXP18132	Twist Lock Shorting Cap Provides Fixed Service to Fixture (Fixture Always on). IP65, Rated Load 7200w Tungsten.
FXP18140	110-120VAC Instant Twist Lock Photocell
FXP18152	277VAC Time Delay Twist Lock Photocell
FXP18156	120-277VAC Universal Twist Lock Photocell
FXP18157	480VAC Time Delay Twist Lock Photocell. For 480V use only.
FXACCHSG1Z	Die Cast Accessory Housing for Installing Sensors or Other Lighting Controls, Bronze Powdercoat Finish
FXKH45GSZ	Aluminum Glare/House Side Shield, Bronze Powdercoat Finish, Includes Hardware. FXKH55Q Requires Two.
FXKH45WG	Wire Guard, Stainless Steel Construction, Includes Hardware. FXKH55Q Requires Two.
FXACCHSG3	Bronze UV-Stabilized Polycarbonate Housing for Installing Sensors, Includes Sensor Bracket and Gasket.

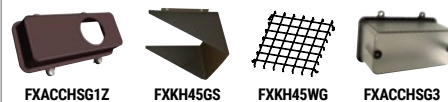

FXACCHSG1Z FXKH45GS FXKH45WG FXACCHSG3

## Replacement Parts

(Order Separately, Field Installed)

Options	Description
FXKH45GL	Tempered Clear Flat Glass Lens.
FXKH45GLSS	SoftLED Flat Glass Lens
FXKH45GLP	Tempered Prismatic Flat Glass Lens.
FXFL90SFZX	External Mount Die-Cast Adjustable Slipfitter for 2 3/8" Tenons, Bronze Powdercoat Finish, Includes Hardware.
FXP17117	Internal Microwave Sensor with Dimming, 120-277VAC, 50/60Hz. See FXP17117 Specification Page for Details.
FXP17123	Internally Mounted Microwave On/Off Motion Sensor for Mounting Heights of 8' to 19', 120-277VAC, 50/60Hz



FXP17117 FXP17123

FXLSolutions.com • (800) 533-2789 • info@FXLSolutions.com

# EasyLED Bentley Kitty Hawk Powerbolt

FXKH55Q

SOFTLED • POWERBOLT • AREA LIGHT • FLOOD LIGHT





## FXKH55Q MOUNTING OPTIONS



### FXKH55Q w/ "SF" External Mount Slipfitter (SF)

External Mount Die-Cast Adjustable Slipfitter for 2 3/8" Tenons, Bronze Powdercoat Finish, Includes Hardware.

## EFFECTIVE PROJECTED AREA (EPA)

Configuration	EPA (Sq. Ft.)	Weight (Lbs.)
 1	1.20	74 Lbs
 2@180° Mount	2.40	148 Lbs

Shown with Slipfitter mounting.

## FXKH55Q PHOTOMETRIC DATA FOR AREA & WALL APPLICATIONS

Lumen Package	Optic	CCT	Wattage (Catalog Logic)			
			Input Watts	Optimized 272W (2X136)	334W (2X167)	Optimized 450W (2X225)
			297W	358W	483W	549W
			Delivered Lumens			
FXKH55Q	Type I	3000K	-	-	-	-
		4000K	-	43,287	-	66,357
		5000K	-	44,974	-	68,942
		BUG Rating	-	B5-U0-G3	-	B5-U0-G4
	Type II	3000K	-	-	-	-
		4000K	-	41,295	-	63,303
		5000K	-	42,904	-	65,769
		BUG Rating	-	B4-U0-G3	-	B5-U0-G4
	Type III	3000K	-	43,597	-	66,831
		4000K	42,331	45,364	68,609	69,541
		5000K	43,981	47,132	71,283	72,250
		BUG Rating	B4-U0-G4	B4-U0-G4	B5-U0-G5	B5-U0-G5
	Type IV	3000K	-	-	-	-
		4000K	42,910	45,984	69,571	57,380
		5000K	44,582	47,776	72,256	59,615
		BUG Rating	B4-U0-G5	B4-U0-G5	B4-U0-G5	B4-U0-G5
	Type V	3000K	-	41,586	-	63,750
		4000K	40,379	43,272	65,446	66,334
		5000K	41,952	44,958	67,996	68,918
		BUG Rating	B5-U0-G2	B5-U0-G2	B5-U0-G3	B5-U0-G3

FXLSolutions.com • (800) 533-2789 • info@FXLSolutions.com

# EasyLED Bentley Kitty Hawk Powerbolt

FXKH55Q

SOFTLED • POWERBOLT • AREA LIGHT • FLOOD LIGHT



## FXKH55Q PHOTOMETRIC DATA FOR FLOOD APPLICATIONS

			Optimized	334W (2X167)	Optimized	512W (2X256)
Wattage (Catalog Logic)			272W (2X136)		450W (2X225)	
Input Watts			297W	358W	483W	549W
Lumen Package	Beam	CCT	Delivered Lumens			
FXKH55Q	130°H x 70°V, NEMA 7H x 5V	3000K	-	-	-	-
		4000K	-	43,258	-	66,312
		5000K	-	44,944	-	68,895
	110°H x 30°V, NEMA 7H x 6V	3000K	-	-	-	-
		4000K	-	41,350	-	63,387
		5000K	-	42,961	-	65,857
	120°H x 70°V, NEMA 7H x 7V	3000K	-	43,284	-	66,352
		4000K	42,028	45,039	68,118	69,042
		5000K	43,665	46,794	70,772	71,732
	110°H x 30°V, NEMA 6H x 5V	3000K	-	-	-	-
		4000K	42,438	45,479	68,782	56,754
		5000K	44,092	47,250	71,462	58,965
	110°H x 110°V, NEMA 7H x 7V	3000K	-	41,693	-	63,913
		4000K	40,482	43,383	65,613	66,504
		5000K	42,060	45,074	68,170	69,094
	30°H x 30°V, NEMA 4H x 7V	3000K	-	-	-	-
		4000K	-	46,504	-	71,294
		5000K	-	48,316	-	74,070

## FXKH55Q PROJECTED LUMEN MAINTENANCE

Data shown for 5000 CCT		Compare to MH				
TM-21-11	Input Watts	Initial	25,000 Hrs	50,000 Hrs	100,000 Hrs	Calculated LED Life
L70 Lumen Maintenance @ 25°C / 77°F	All wattages up to and including 549w	1.00	0.97	0.95	0.90	290,000
L70 Lumen Maintenance @ 50°C / 122°F		1.00	0.94	0.88	0.76	84,000
L80 Lumen Maintenance @ 40°C / 104°F		1.00	0.95	0.91	0.81	108,000

**NOTES:**

1. Projected per IESNA TM-21-11. Data references the extrapolated performance projections for the base model in a 25°C ambient, based on 10,000 hours of LED testing per IESNA LM-80-08.
2. Compare to MH box indicates suggested Light Loss Factor (LLF) to be used when comparing to Metal Halide (MH) systems.

FXLSolutions.com • (800) 533-2789 • info@FXLSolutions.com

# EasyLED Bentley Kitty Hawk Powerbolt

FXKH55Q

SOFTLED • POWERBOLT • AREA LIGHT • FLOOD LIGHT



## FXKH55Q DISTRIBUTION FOR AREA & WALL APPLICATIONS

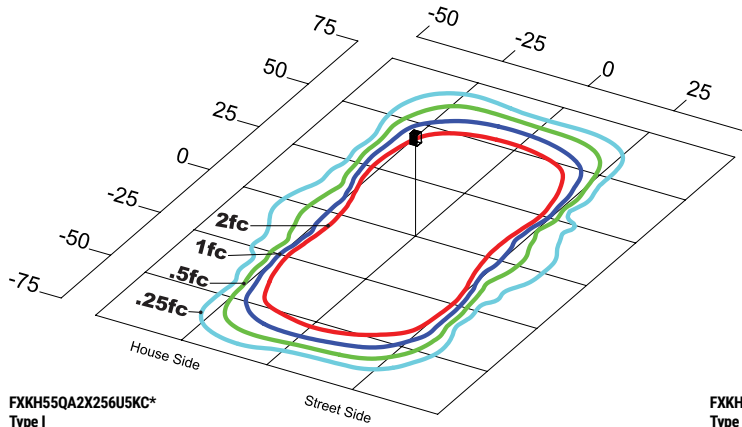

**FXKH55QA2X256U5KC\***  
Type I  
Grid in MH  
MH=25 Feet

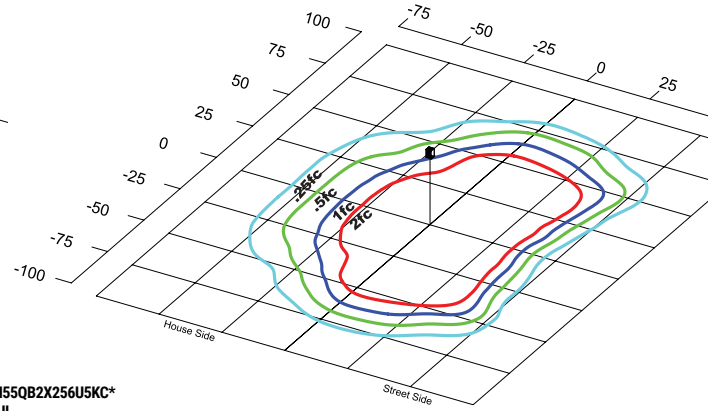

**FXKH55QB2X256U5KC\***  
Type II  
Grid in MH  
MH=25 Feet

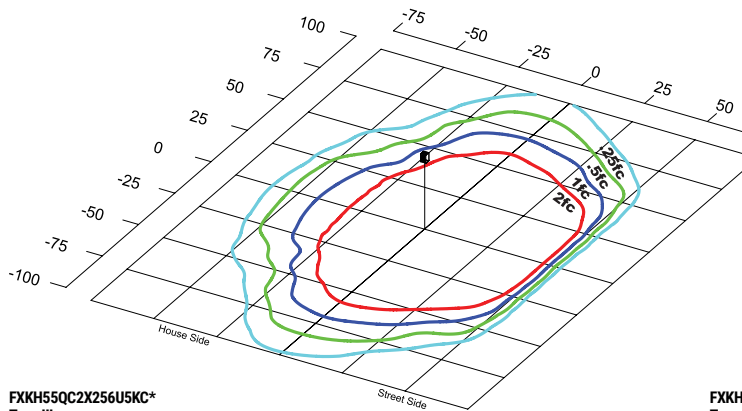

**FXKH55QC2X256U5KC\***  
Type III  
Grid in MH  
MH=25 Feet

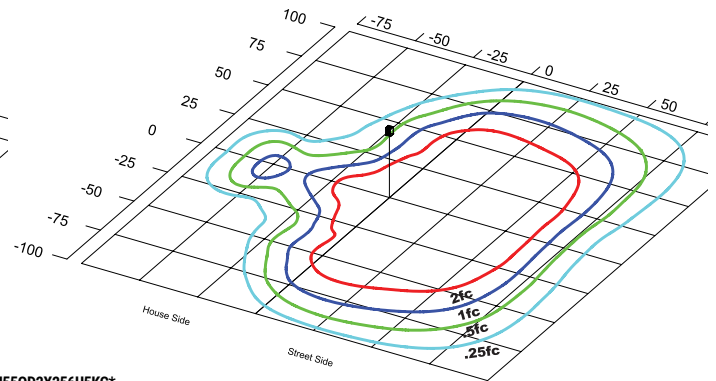

**FXKH55QD2X256U5KC\***  
Type IV  
Grid in MH  
MH=25 Feet

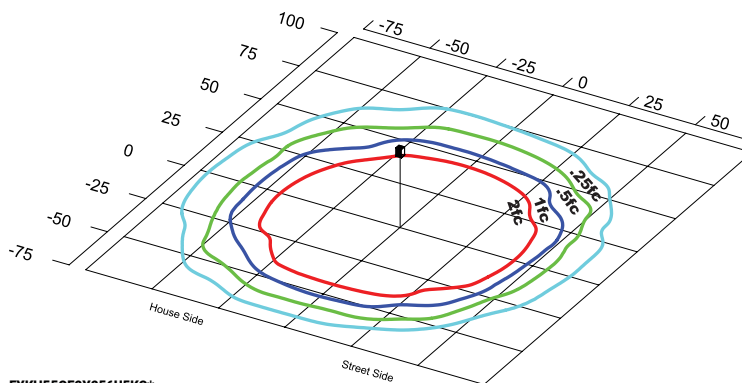

**FXKH55QF2X256U5KC\***  
Type V  
Grid in MH  
MH=25 Feet

FXLSolutions.com • (800) 533-2789 • info@FXLSolutions.com

# EasyLED Bentley Kitty Hawk Powerbolt

FXKH55Q

SOFTLED • POWERBOLT • AREA LIGHT • FLOOD LIGHT



## FXKH55Q DISTRIBUTION FOR FLOOD APPLICATIONS

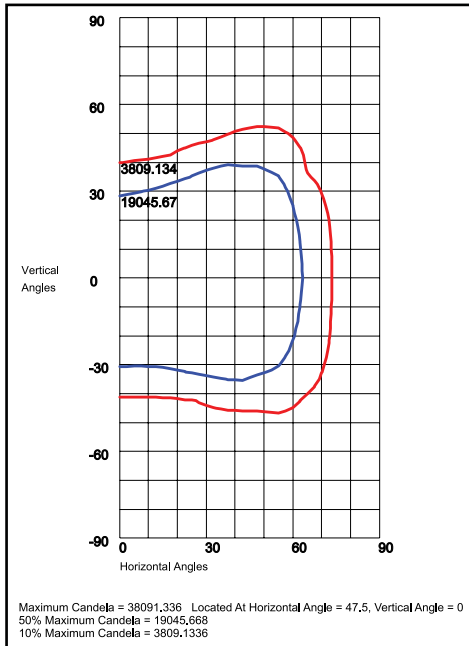

**FXKH55QA2X256U5KC**  
 130°H x 70°V, NEMA 7H x 5V

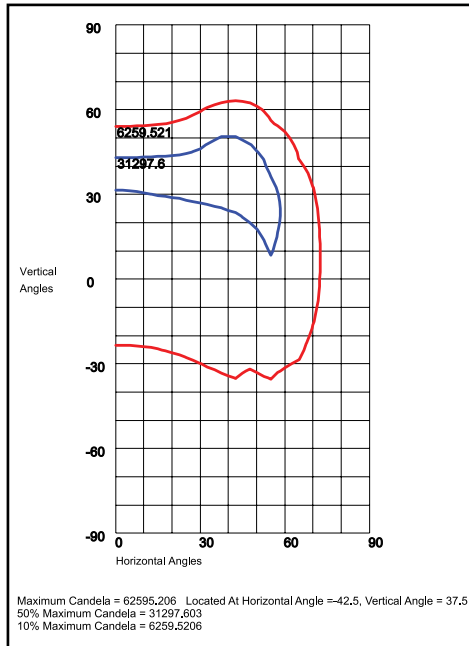

**FXKH55QB2X256U5KC**  
 110°H x 30°V, NEMA 7H x 6V

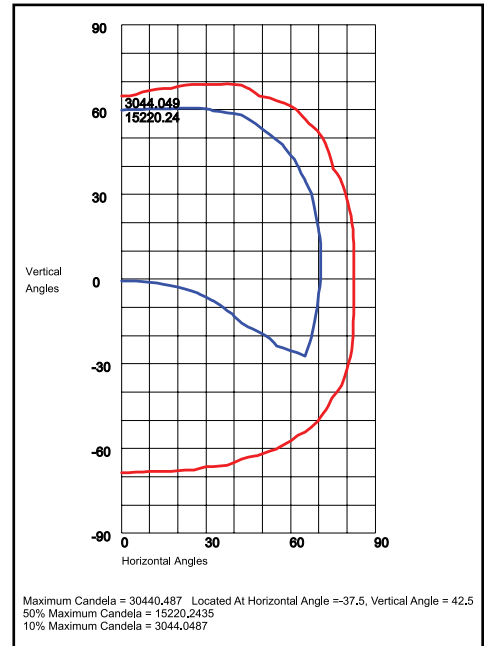

**FXKH55QC2X256U5KC**  
 120°H x 70°V, NEMA 7H x 7V

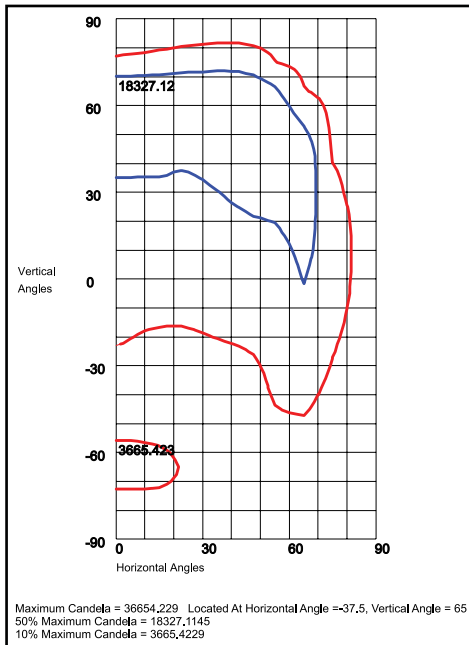

**FXKH55QD2X256U5KC**  
 110°H x 30°V, NEMA 6H x 5V

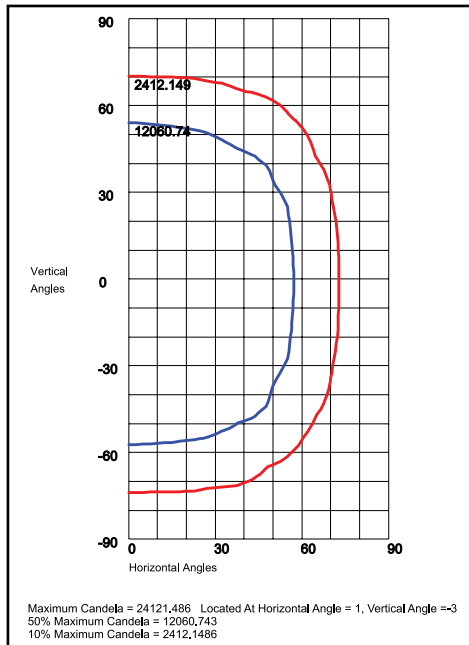

**FXKH55QF2X256U5KC**  
 110°H x 110°V, NEMA 7H x 7V

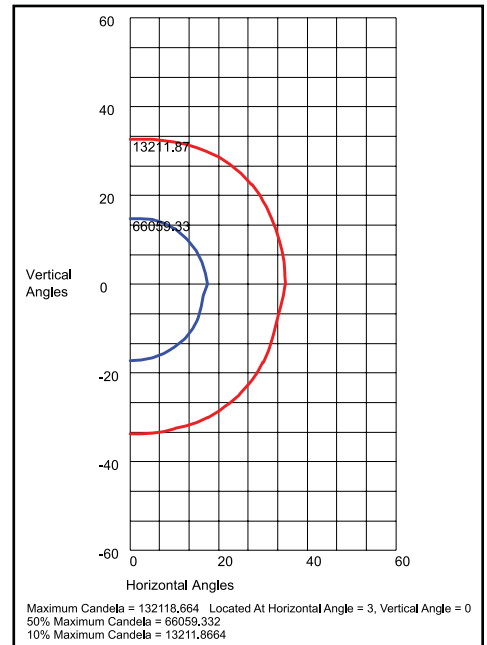

**FXKH55QI2X256U5KC\***  
 30°H x 30°V, NEMA 4H x 4V

FXLSolutions.com • (800) 533-2789 • info@FXLSolutions.com

Information provided is subject to change. Please verify all details with FX Lighting. All values are designed to standard industry values when measured under laboratory conditions, and FX Lighting makes no warranty or guarantee, expressed or implied, that such performance will be obtained under end-use conditions.

# EasyLED Bentley Kitty Hawk Powerbolt

FXKH55Q

SOFTLED • POWERBOLT • AREA LIGHT • FLOOD LIGHT



**FX**  
LIGHTING™  
A QSSI Company Since 1985

## FXKH55Q DIMENSIONAL DATA

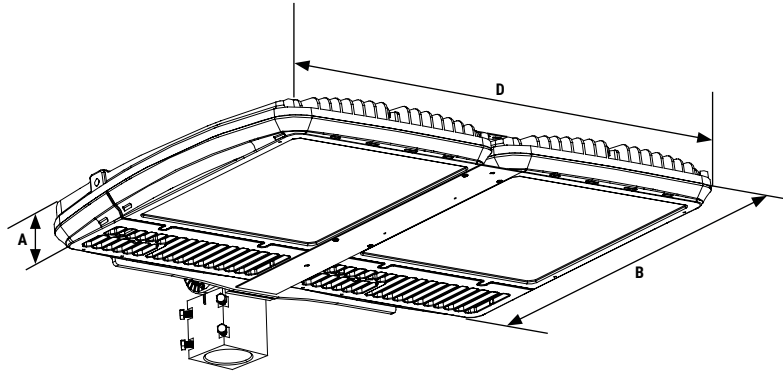

### FXKH55Q with Slipfitter Dimensions

Width (D)	31½" (798mm)
Length (B)	22" (563mm)
Height (A)	4" (102mm)

FXLSolutions.com • (800) 533-2789 • info@FXLSolutions.com

Information provided is subject to change. Please verify all details with FX Lighting. All values are designed to standard industry values when measured under laboratory conditions, and FX Lighting makes no warranty or guarantee, expressed or implied, that such performance will be obtained under end-use conditions.

REV. 08/13/21 7